

DRILL BITS

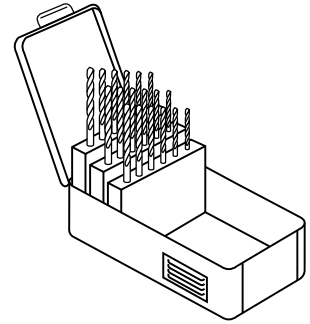

DRILL BIT SETS

High Speed Steel, Heavy Duty Jobber Lengths
Glass, Ceramic, Tile Drill Bits



HIGH SPEED DRILL BITS

Jobber

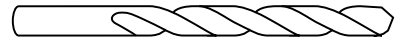

Reduced Shank

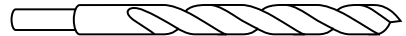

Stubby



MASONRY DRILL BITS

Full Length

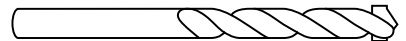

Tapcon



SDS Rotary

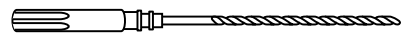

DRIVER, HEX BASE MAGNETIC TIPS

Phillips 1/4 Hex Drive - #s 1, 2 & 3

Slotted 1/4 Hex Drive - #s 1, 2, 3, 4 & 5

Square 1/4 Hex Drive - #s 1, 2 & 3

Torx 1/4 Hex Drive - #s 8, 15, 25, 30 & 40

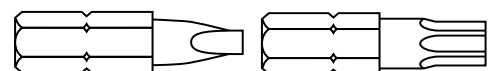
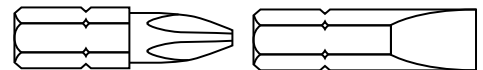



DRILL BITS

DRIVER, HEX BASE MAGNETIC SECURITY TIPS

- Phillips Head W/Pin 1/4 Hex Drive - #s 2 & 3
- Spanner Head 1/4 Hex Drive - #s 6, 8, 10, 12 & 1/4
- Hex Head W/Pin 1/4 Hex Drive - 3/32, 1/8, 5/32, 3/16, 7/32 & 1/4
- Torx Head W/Pin 1/4 Hex Drive - #s 8, 9, 10, 15, 20, 25, 27, 30, 40, 45 & 50

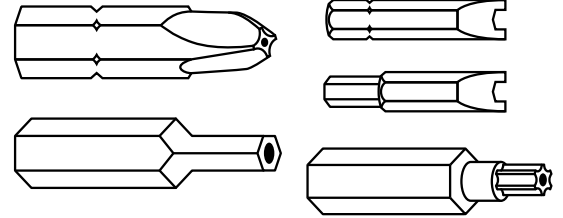

DRIVER, HEX BASE MAGNETIC CHUCK

- 1/4 Drive For #s 6 & 8 Hex Heads
- 5/16 Drive For #s 10 & 12 Hex Heads
- 3/8 Drive For #14 Hex Heads

